

# Making Miniature Books

and

## Other Simple Books

### Make a Miniature Book



#### **Tools & Materials needed to make one 5.5cm x 4cm miniature book:**

Light weight paper – 1 sheet of A4 plain paper (computer printer paper is perfect); This sheet will make two miniature books; A range of coloured paper for covers; Decorative papers – for example, wrapping paper or origami paper, for covers and endpapers; Scissors; Small elastic band (3cm diameter); Small plastic ruler; Bull dog clip or clothes peg; Pencil; Stick glue

#### **Fold your paper**

1. Fold the A4 in half, short side to short side – Take your time to try and match the corners and then flatten the paper with your hand.
2. Now hold your ruler between your thumb and fingers and firmly run it along the crease.
3. Use your ruler to firmly crease your paper every time you fold it.
4. Cut or tear the A4 sheet in half, short side to short side.



*Save one half to make another book later.*

5. Fold the paper in half, short side to short side, and in half again, short side to short side, And in half again, short side to short side.
6. Open the paper up - there will be 8 rectangles.. These rectangles will become pages of your book

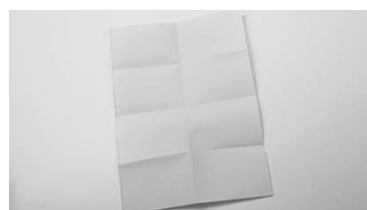

the

7. Cut the paper with scissors, so you have four sets of folded double pages.
8. Fold the cut sheets in half, short side to short side.
9. Put the folded pieces inside one another.
10. This folded block will become the pages of your book. It is called the book block. Put the book block to one side.



### Make your cover boards

1. Open your book block, place it on the plain side of the cover card and draw round it.

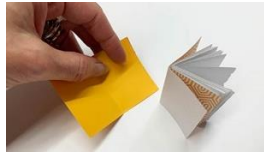

2. Add an extra 2mm to the height and extra 3mm to the width.

### Make a spine strip.

1. Cut a strip of plain or decorative paper the same height as your cover by 2cm.
2. Using stick glue, glue the spine strip to the outside cover of your book.



### Assemble your book

1. Wrap the cover around your book block. Open the entire book to the middle page and “bind” your book together with the elastic band.
2. Enjoy writing and drawing in your book!

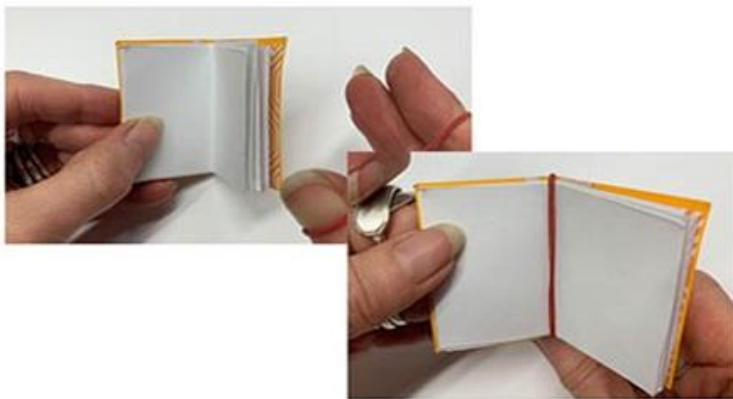

Can you make a smaller book?

# MAKING SIMPLE BOOKS

The simplest book designs are suitable for KS1 or lower KS2 children to make themselves, working in groups under the supervision of a TA. Others are more appropriate for upper KS2 pupils to tackle either in supervised groups (craft knives are used in some!) or even as a whole class activity. They might be making them for their own Literacy or Topic work, or for writing stories etc. to give to younger children in the school.

All the books are made from a single sheet of A3 paper or thin card. As mistakes are likely it is best to have a trial run using A3 photocopying paper before using card. Thin card is best for pop-up books, but ordinary paper is fine for most others. A compromise solution is to make the body of the book from A3 paper and use an off-cut of card for the cover.

## BASIC BOOK FORMS

*Concertina book*

*Origami book*

*Pop-up box book*

*Pop-up face book*

*Beginning-middle-end book*

*Lift the flap book*

*Book review book*

# ***Concertina book***

1. Take a sheet of A3 paper in landscape position and fold the left edge to the right edge, then open out again.
2. Fold the left and right edges to the centre and open out.
3. You now have 4 vertical panels.
4. Now fold the top edge to the bottom. This effectively doubles the stiffness of the paper and allows it to stand up without flopping. (An age old problem. Or a problem of old age.)
5. Fold the 4 panels along the vertical creases in a concertina to make the basic book.
6. A thin piece of card can be glued to the front and back to enhance appearance or strengthen the concertina.
7. If using thin card, after Stage 3 instead of folding over to strengthen (unnecessary), cut along that fold to give 2 identical strips which can be glued together to make an extended concertina book.

# *Origami book*

1. Follow the instructions for a concertina book to Stage 4. Unfold the paper to reveal 8 identical rectangular panels.
2. Fold the left edge to the right edge. Cut through the centre of the fold along the crease to the next vertical crease.
3. Open out the sheet to reveal a slot two panels wide in the centre.
4. Fold the top edge to the bottom edge.
5. Slightly tricky bit, push the left and right edges towards the centre to form a cuboid.  
Note: it helps to fold all the creases both ways beforehand.
6. Continue pushing the edges to the centre to make a cross.
7. Take two adjacent pages and fold them around all the other pages. Crease the spine and edges thoroughly.
8. You now have a basic book shape. Again, covers can be glued on if required. Likewise, the pages can be lightly glued together for rigidity and presentation if so desired.
9. The origami book is used as the basis for several of the other designs.

# ***Pop-up box book***

*Ideal for bringing simple stories or descriptions alive.*

1. Use A3 thin card to make an origami book to Stage 3.
2. Fold the left and right edges to the centre. Cut two parallel slits of about 2cm in each of the two left-hand panels, likewise in the lower right-hand panel.
3. Fold each middle section upwards to make a flap.
4. Unfold the flaps and open out the paper.
5. Fold into an origami book, ensuring that all the pop-up sections are on the inside pages.
6. Open each spread, pull the pop-up forwards and close the book to set the pop-up in position.
7. The pages can now be stuck together if required.
8. The 3 pop-up flaps provide a gluing base for any card shapes to be stuck on. This type of pop-up book is best viewed in landscape orientation.

# ***Pop-up face book***

*Ideal for making monster books or collecting 'This creature says...' type list poems.*

1. Use A3 thin card to make an origami book to Stage 3.
2. Fold the left and right edges to the centre. Cut a 2cm horizontal slit in the centre of 3 of the 4 panels.
3. Fold a large triangular flap up from the slit on the bottom panels, and down on the top panel.
4. Fold a smaller triangular flap down from the slit on the bottom panels, and up on the top panel.
5. Unfold the flaps, then unfold the paper.
6. Fold into an origami book, ensuring that the slit pages are inside.
7. Open each page and pull up the larger triangular pop-up flap to make the nose/beak, and the smaller triangular flap to make the mouth/lower lip.
8. The pages can be glued together if required.

# ***Beginning-middle-end book***

*Ideal for displaying a simple story or piece of writing in three parts.*

1. Cut A3 sheet of thin card in half lengthways to make two identical strips.
2. Take one strip of card and fold edge to edge, opening up and edge to middle crease repeated, so the strip is made up of eight concertina panels.
3. Fold the second strip of card into 4 equal parts and cut into 4 identical panels.
4. You only need 3 panels for this project. Each of the panels will be for the writing. The 4<sup>th</sup> panel can be used for a front cover.
5. The beginning of the story is written (or printed and pasted) on panel 1, the middle on panel 2 and the ending on panel 3.
6. Each section is then glued to a concertina fold.
7. Back and front covers the same size as these panels can be produced and stuck onto the remaining front and back concertina folds.



# ***Lift the flap book***

*Ideal for 'Reveal' descriptive texts or 'Guess the answer' type word games.*

1. Fold A3 sheet of thin card into quarters and unfold.
2. Now fold in half vertically and use a craft knife to cut a flap through the top of both bottom panels.
3. Open up the card and fold the top half behind the bottom half.
4. Fold into a card which has two inside pages each with a flap that can be lifted to reveal whatever is hidden behind.
5. This can be adapted to have several flaps per page if required, for instance to showcase a selection of riddles.

# ***Book review book***

*An eye-grabbing way of presenting a book review or blurb.*

1. Fold A3 thin card in half widthways and then open up again.
2. Use a pencil and ruler to measure then draw a faint line down the centre of the paper lengthways.
3. Holding the paper in portrait orientation, use a craft knife to make two parallel cuts in the bottom section, each starting about 5cm in from the left edge to about 2cm past the vertical pencil line.
4. Fold the top half of the paper behind the bottom half.
5. Slightly tricky bit – Crease each side of the cut section against a ruler to get a nice crisp fold.
6. Another tricky bit – close the book carefully, as you do so, ease the cut section outwards towards the open edge. Smooth down when closed to form the final crease inside the book.
7. On opening you'll have a pop-up blank of the book to be reviewed. The title can be written down the spine, the children can either copy the cover design or devise their own version. The review, blurb or comments can be written on the right-hand side.
8. Note: For a more professional look, why not download an image of the book's cover from the internet. In this case the measurements for the fold are a bit different.
  - 8 (i) At Stage 3 place the image to be used mainly on the left-hand section but overlapping the centre pencil line by 2cm.
  - 8 (ii) Mark where the top right and bottom right corners of the image lie, then make marks 2cm to the left of where the top left and bottom left corners of the image lie. These marks show where to make the two slits. Basically you're cutting a pop up that is the same height as the chosen image but 2cm wider.

**CONCERTINA BOOK**

1.

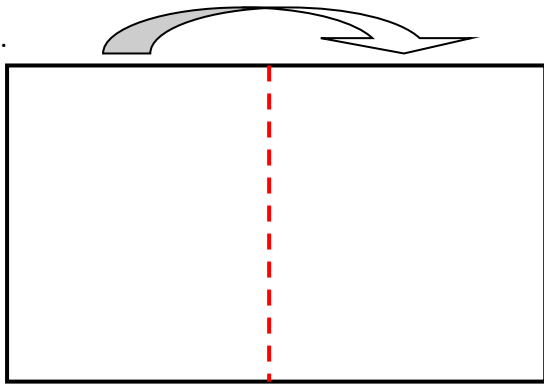

2.

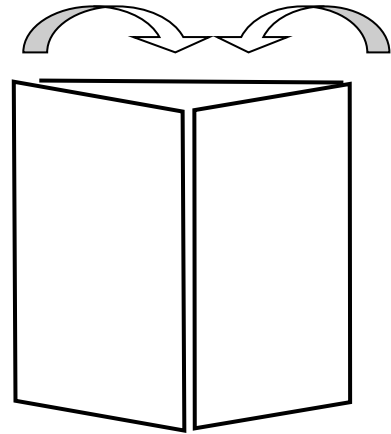

3.

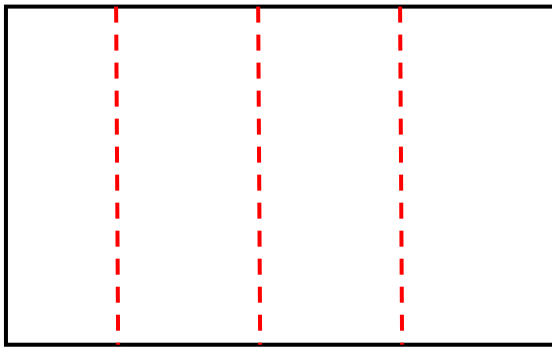

4.

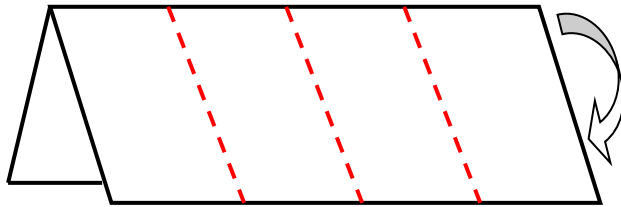

5.

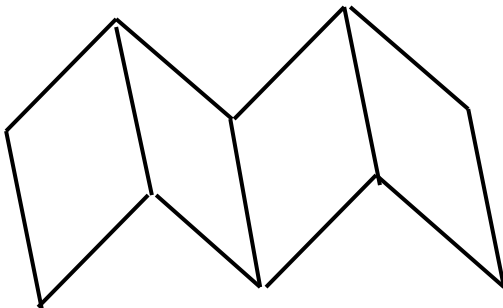

ORIGAMI BOOK

1.

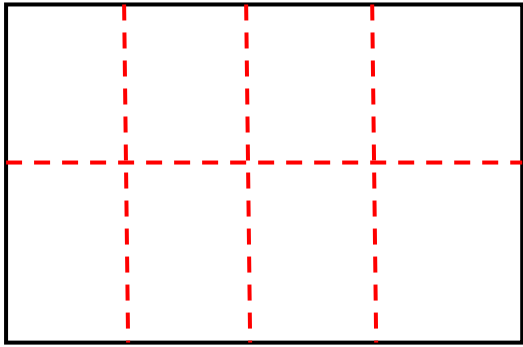

2.

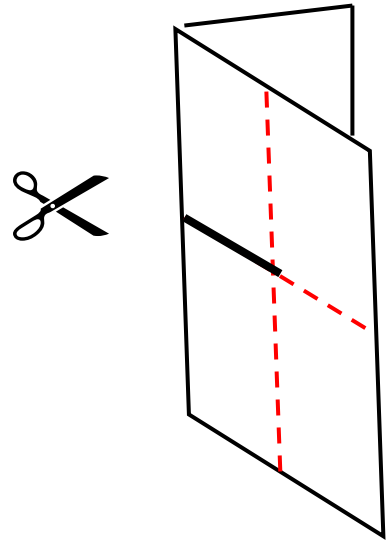

3.

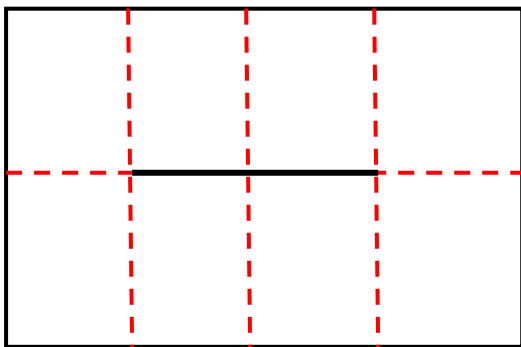

4.

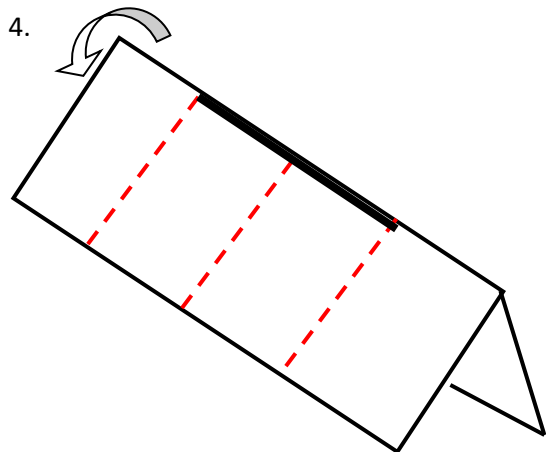

5.

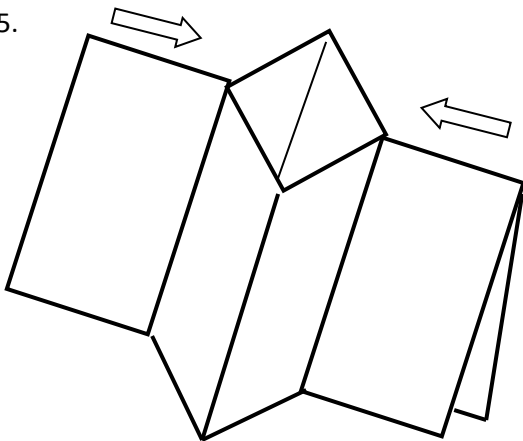

6.

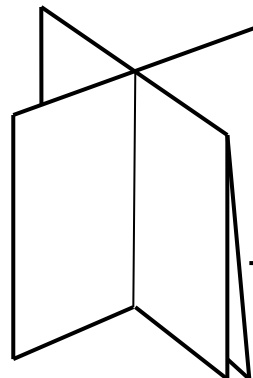

**POP-UP BOX BOOK**

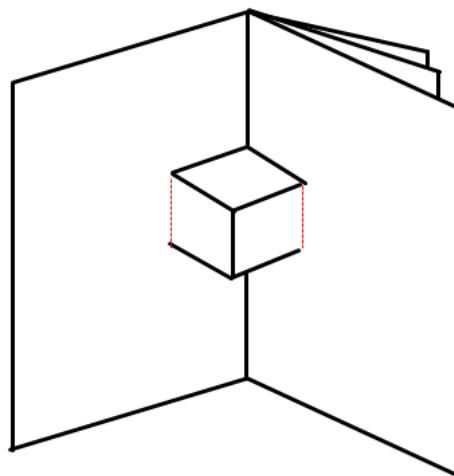
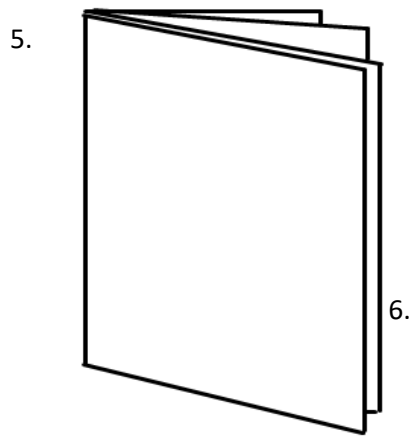
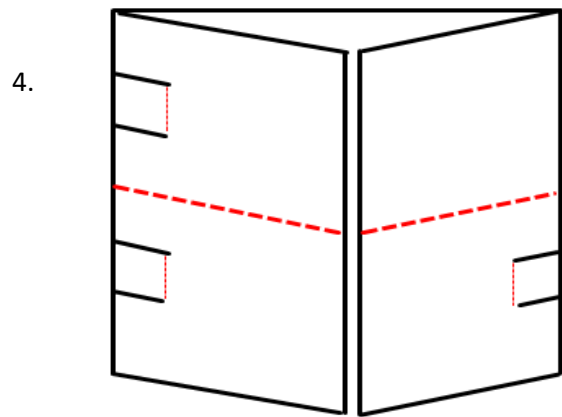
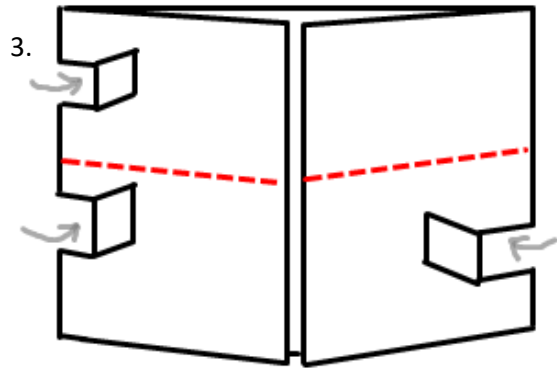
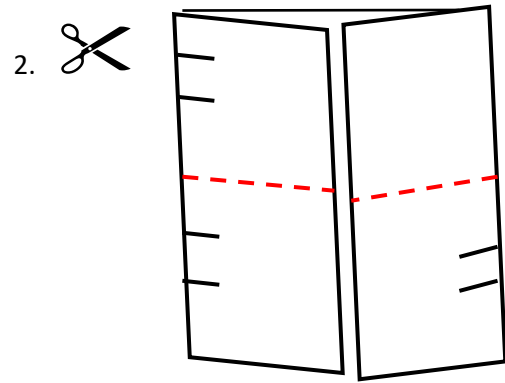
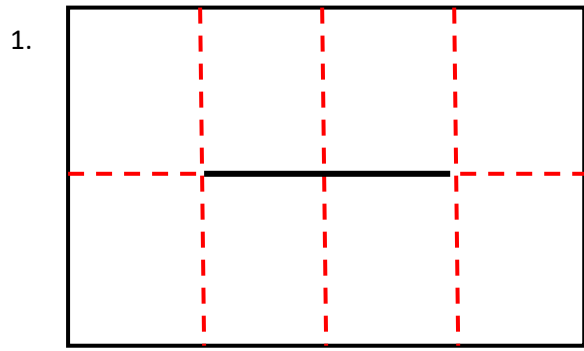

**POP-UP FACE BOOK**

1.

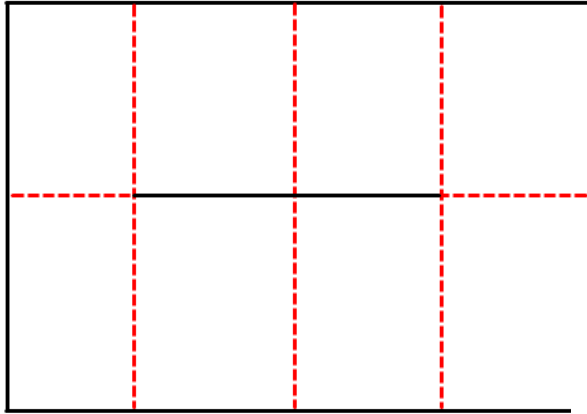

2.

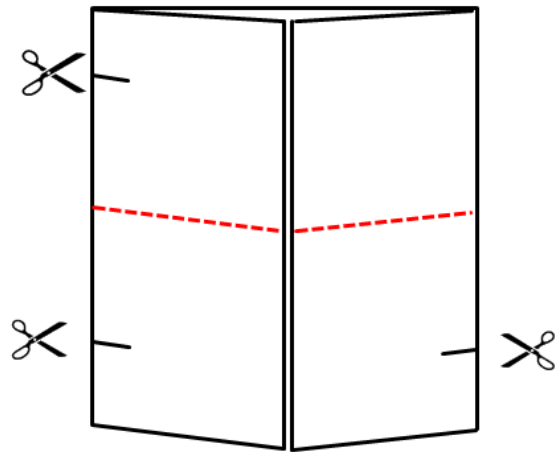

3 & 4.

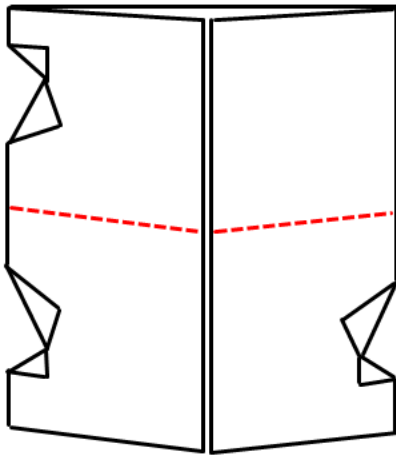

5.

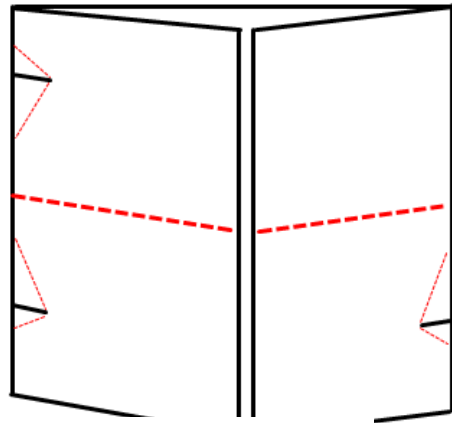

6.

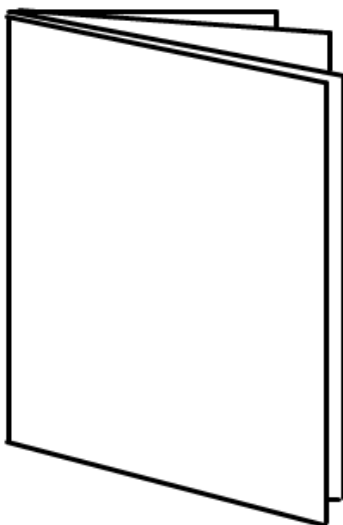

7.

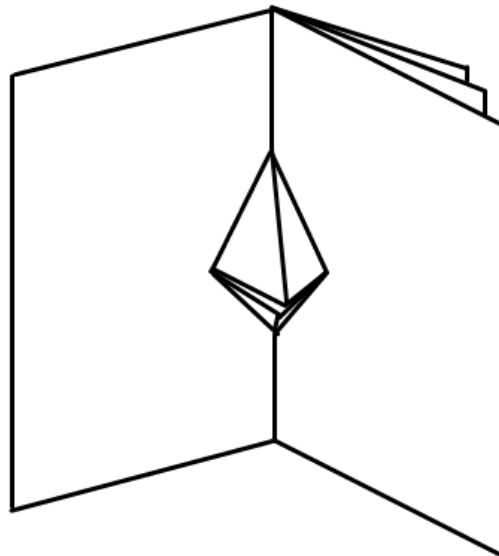

**BEGINNING – MIDDLE – END BOOK**

1.

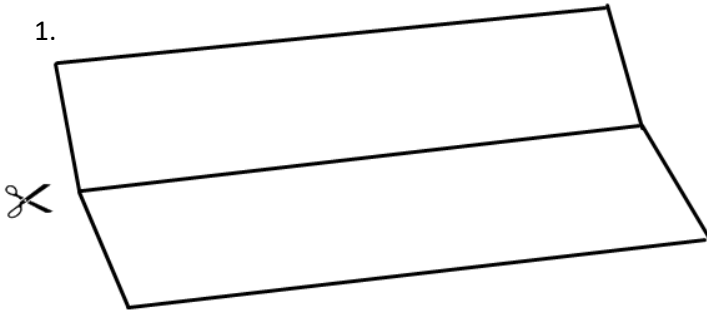

2.

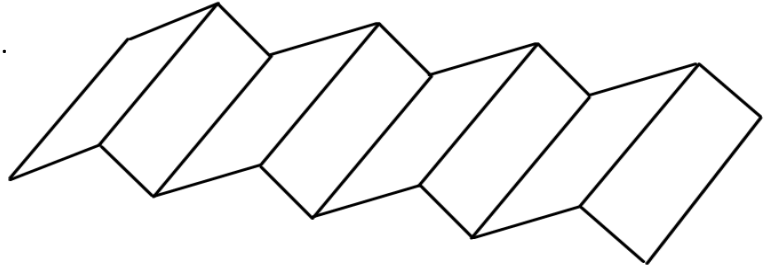

3 & 4.

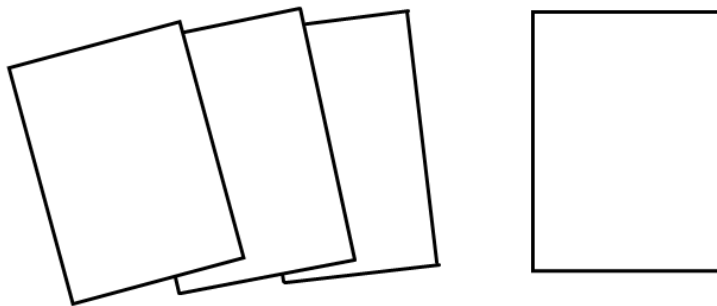

5, 6 & 7.

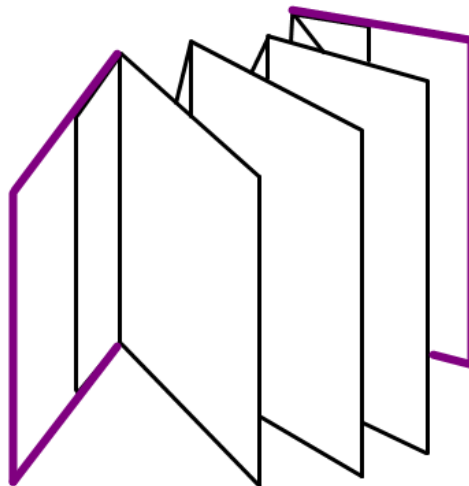

**LIFT THE FLAP BOOK**

1.

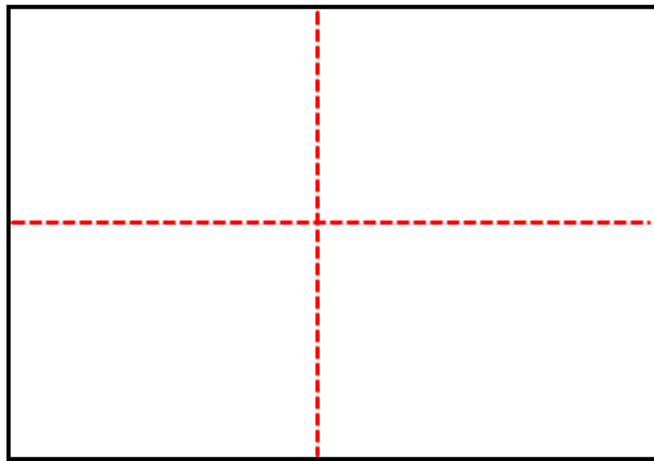

2.

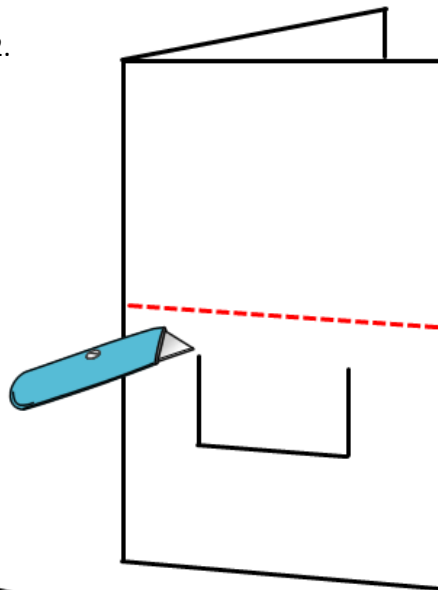

3.

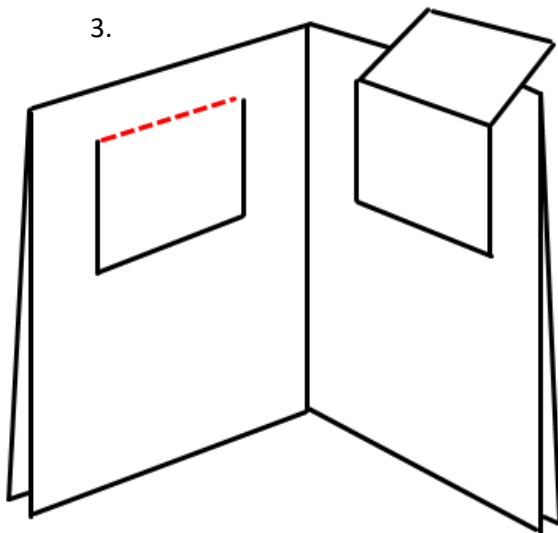



**BOOK REVIEW BOOK**

1.

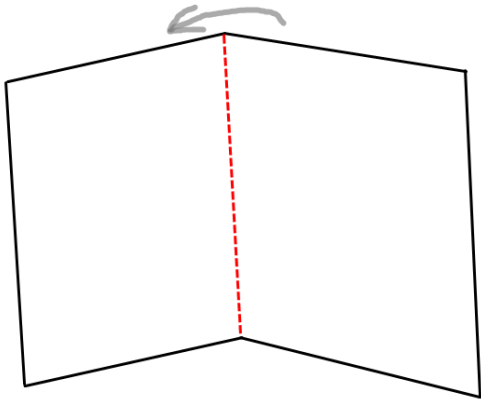

2.

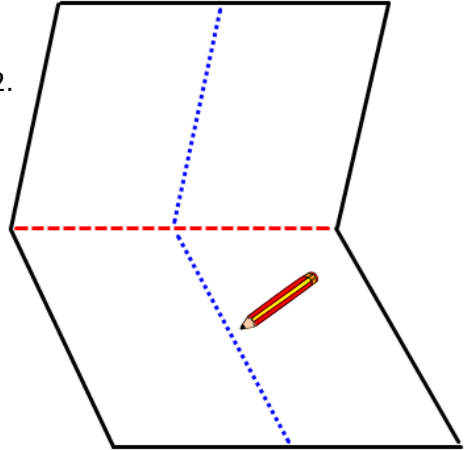

3.

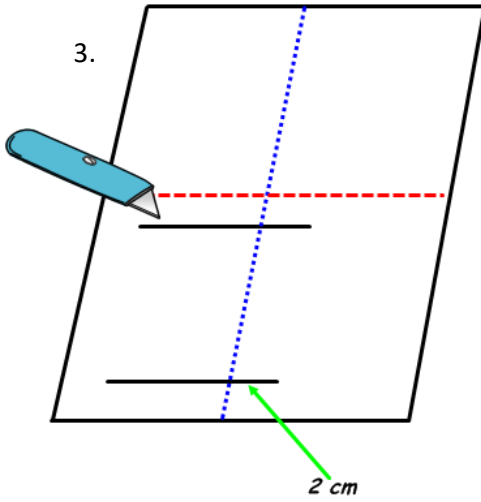

4 & 5.

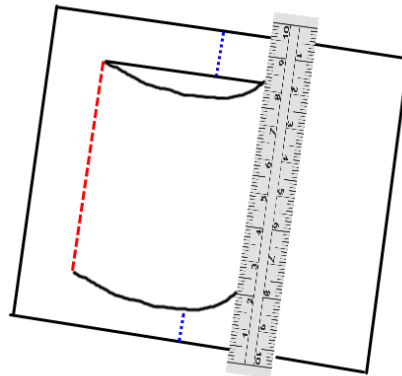

6 & 7.

